

8PL01J

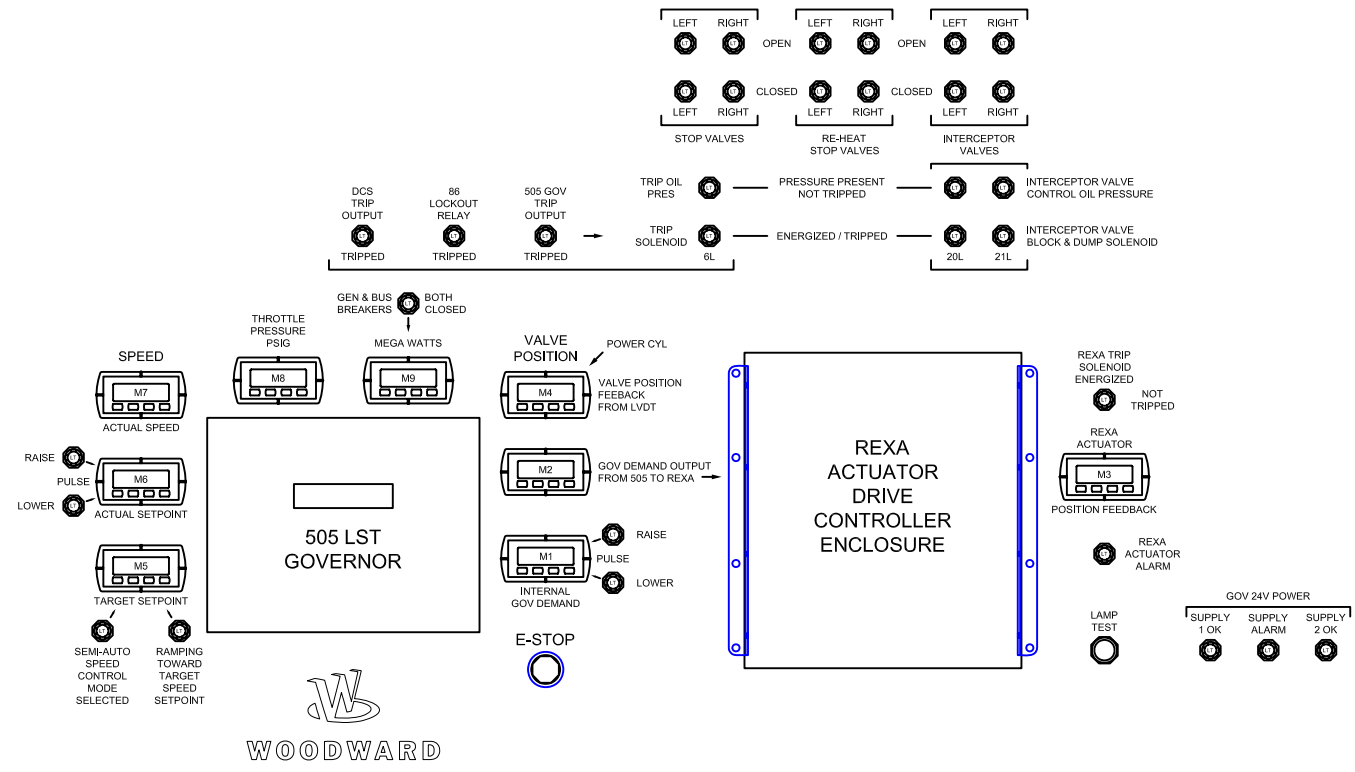

Tasker

P8 TURBINE PANEL FRONT VIEW

FLOOR & BASEBOARD NOT LEVEL, PANEL INSERT SQUARE AND LEVEL, 0,0 AT LEFT LOWER CORNER OF PANEL

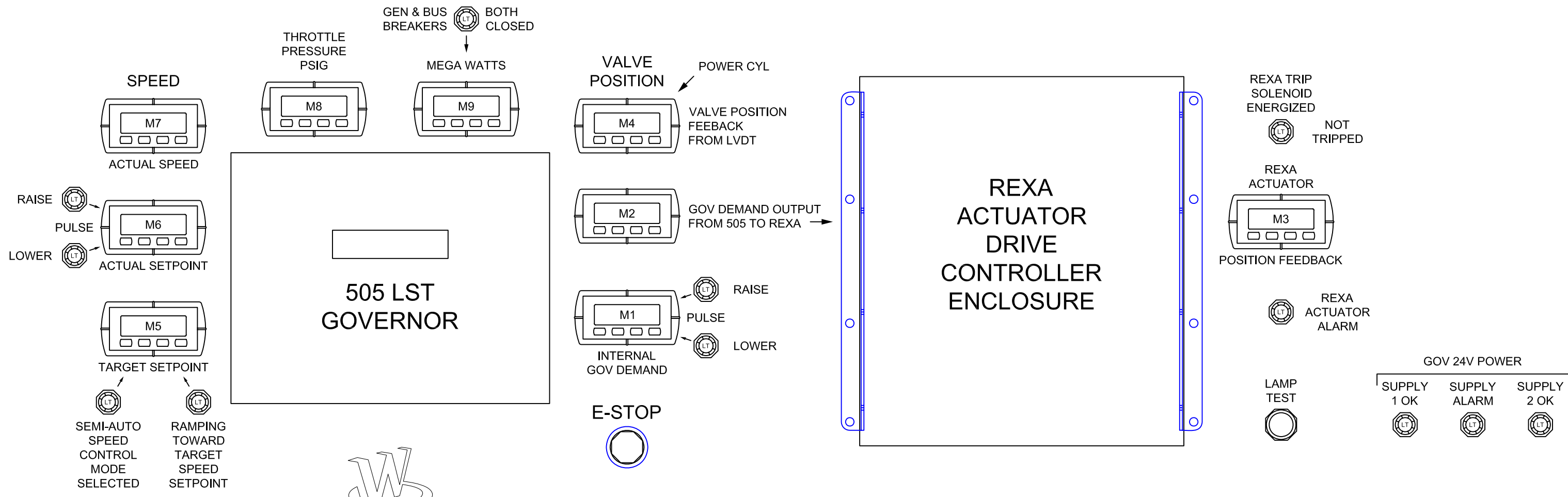
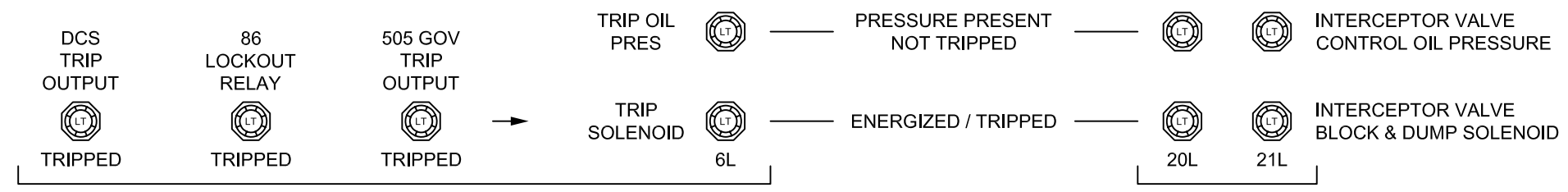
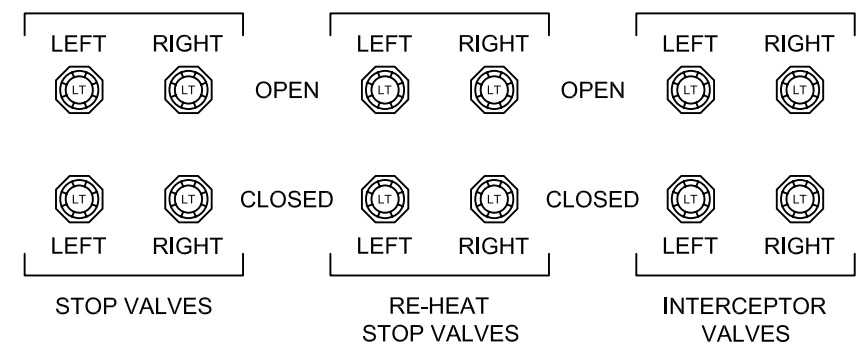

FRONT VIEW ZOOM

DRAFT

PROJECT: WPS / PULLIAM POWER PLANT PULLIAM 8 / ALLIS CHALMERS 125 MW STEAM TURBINE GENERATOR

TITLE: WOODWARD 505 LST / REXA TURBINE CONTROL PANEL SCREEN PRINT / FRONT

EDIT: TT DATE: 10/19/09
ENG: TT DATE:
APVD: DATE:
ENGINEERING GROUP

Tasker 800 852-8850 http://tasker.us

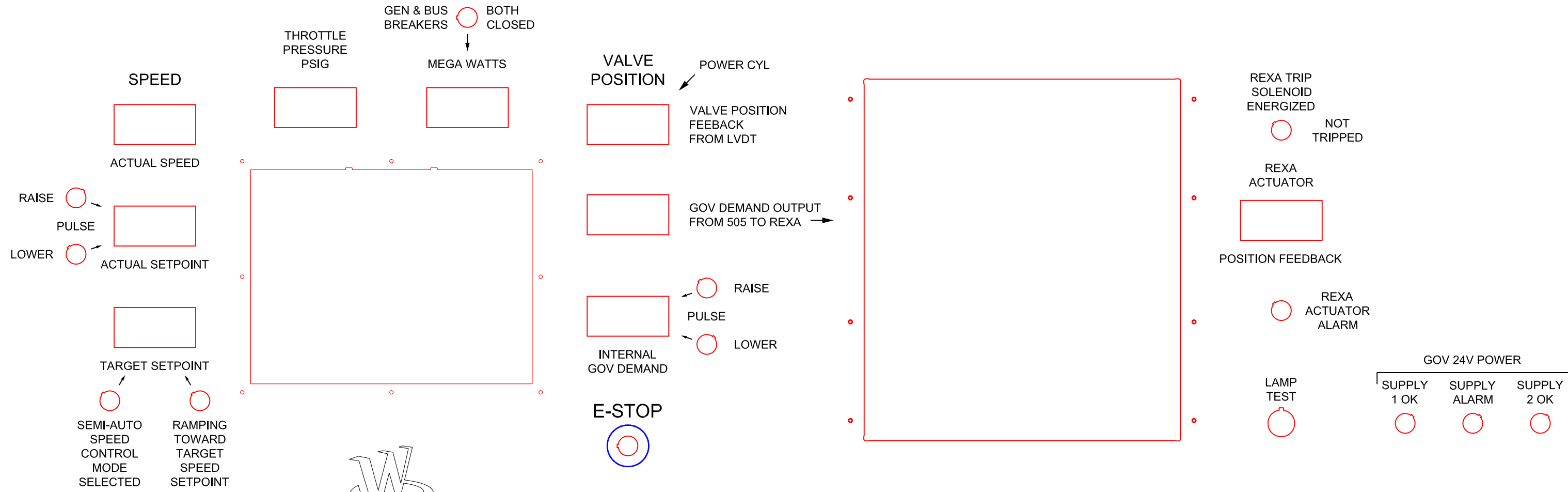
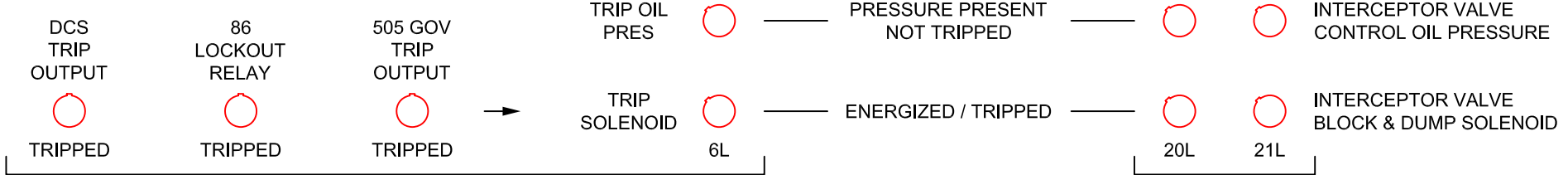
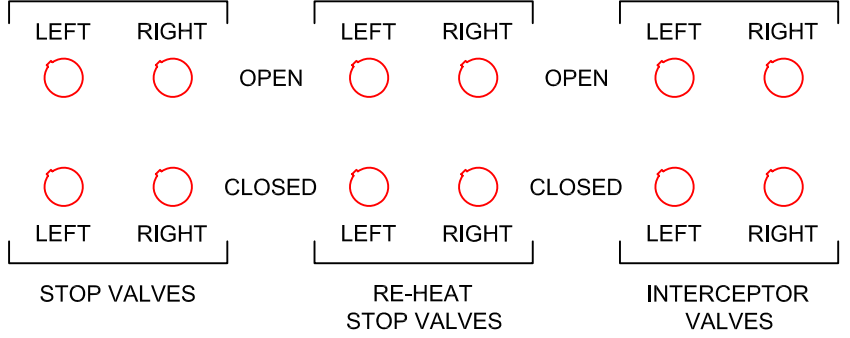

SCREEN PRINT FRONT VIEW

BACK
VIEW

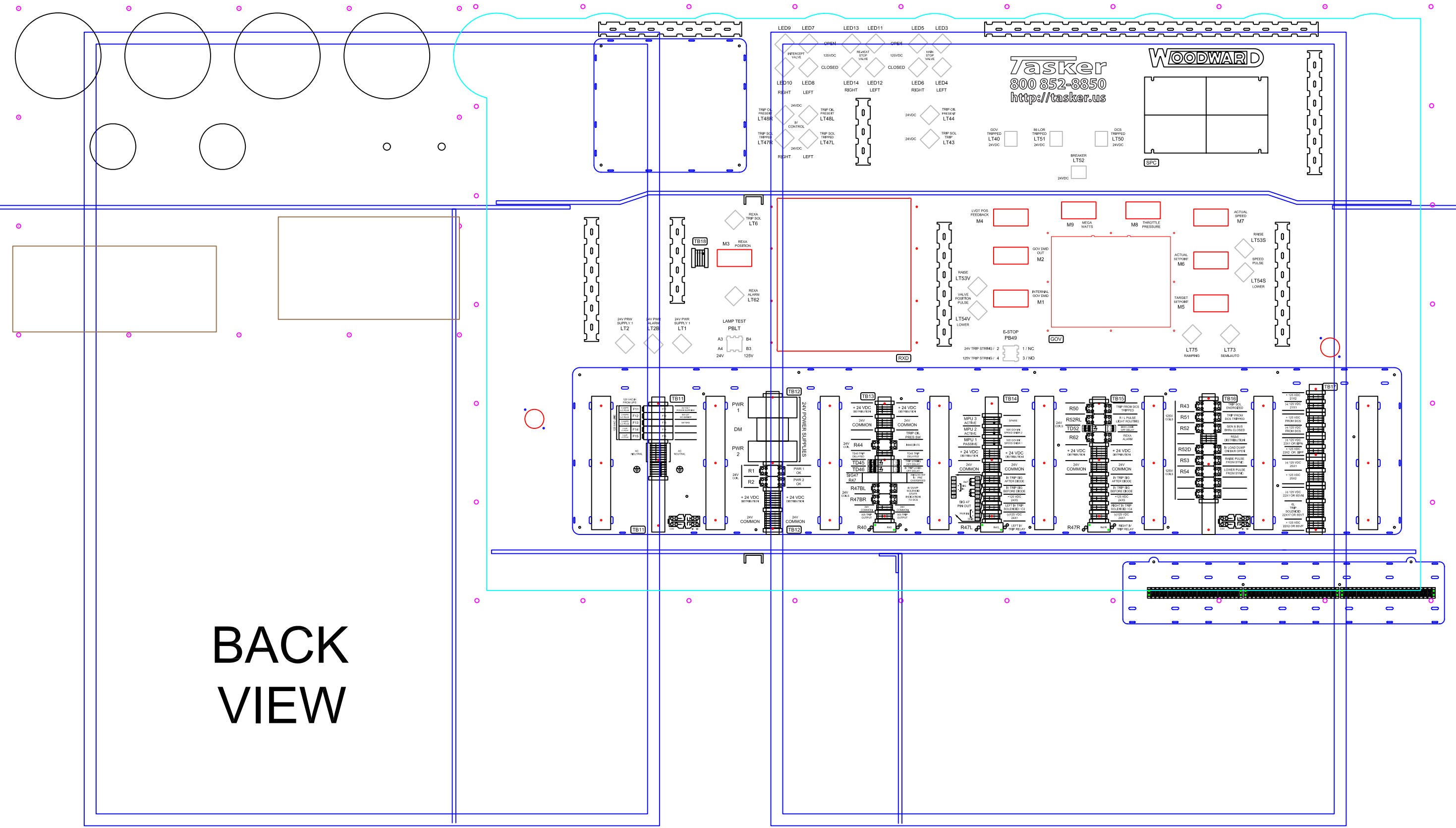

BACK SIDE LABELS

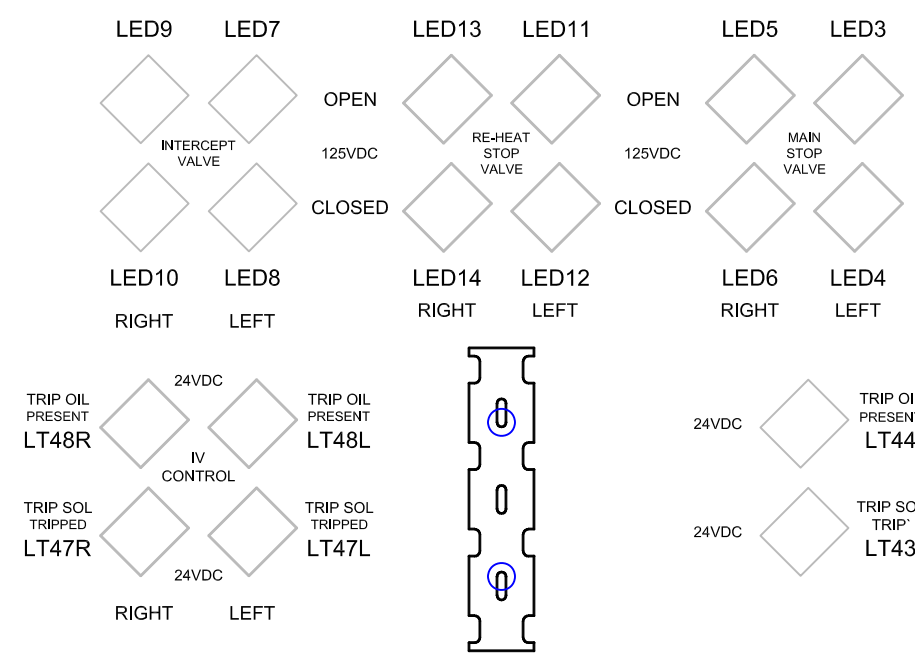

Tasker
800 852-8850
http://tasker.us

WOODWARD

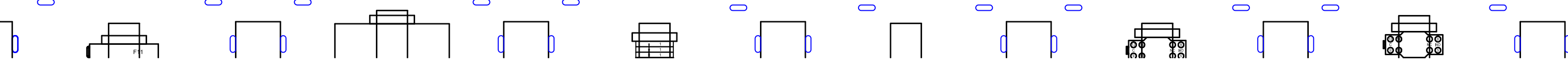
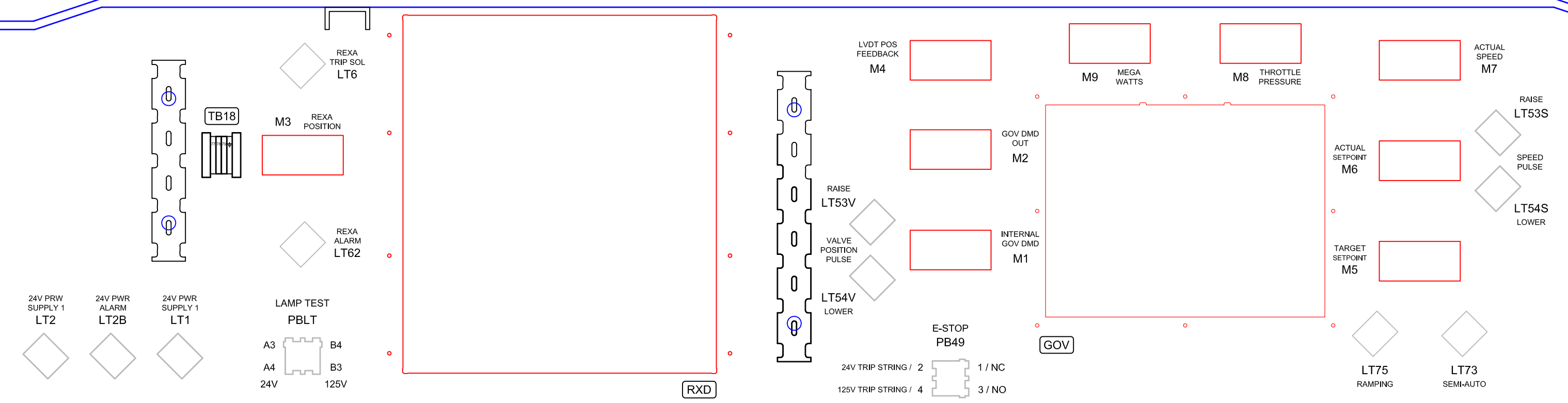
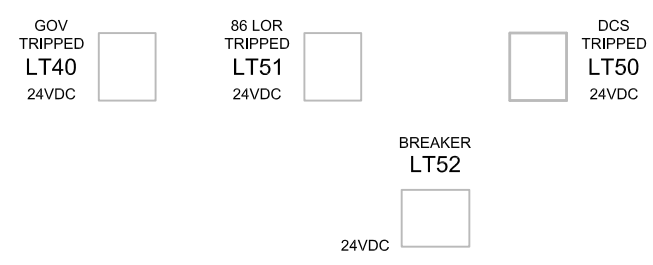
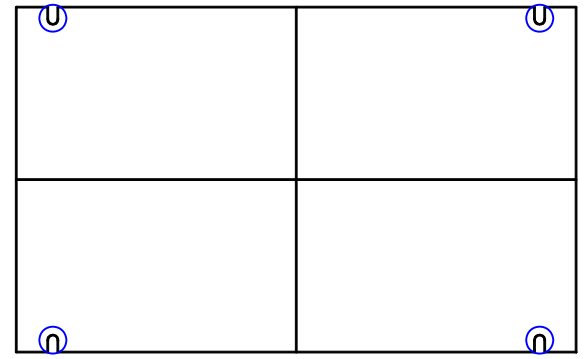

BACK SIDE LABELS

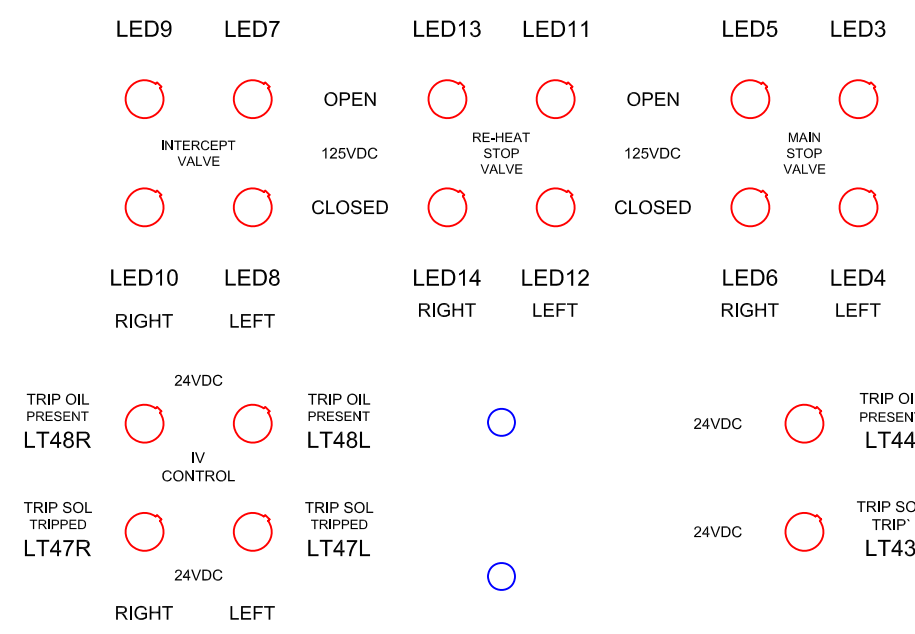

Tasker
800 852-8850
<http://tasker.us>

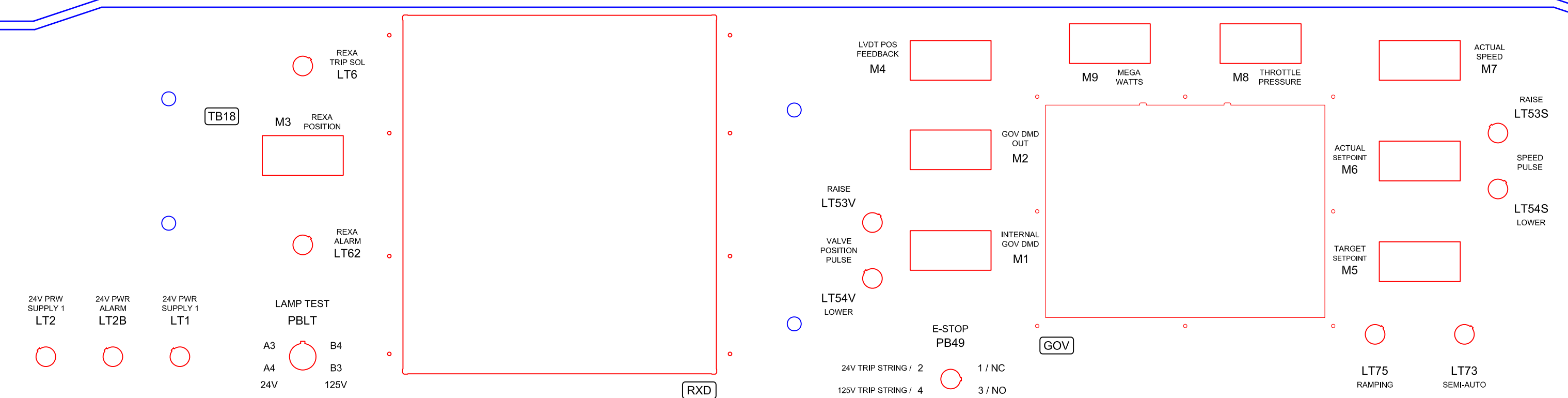
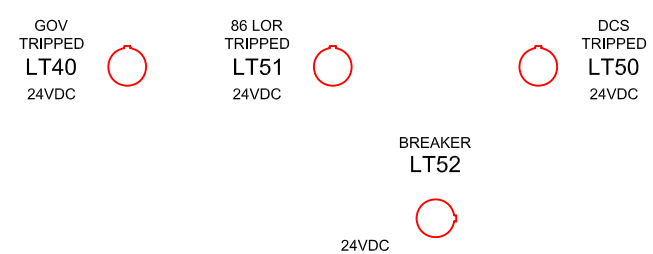

BACK SIDE SUBPANELS

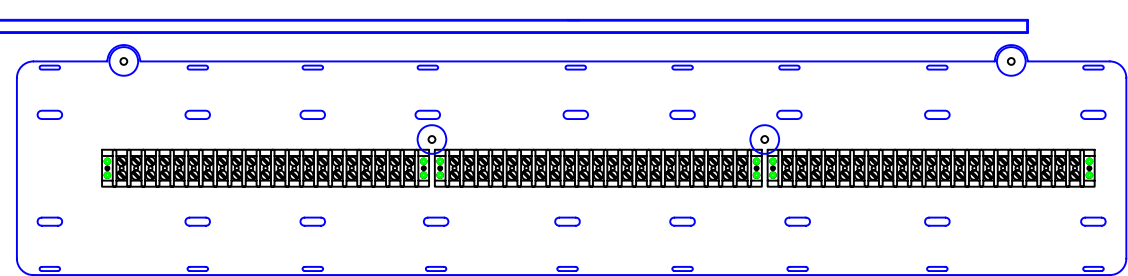
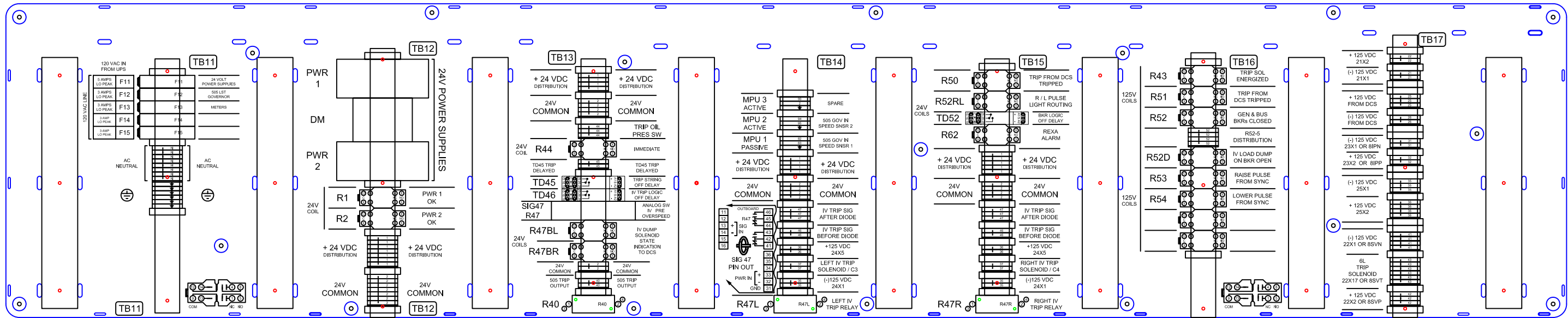

PROJECT: WOODWARD 505 LST / REXA TURBINE CONTROL PANEL BACK SIDE SUBPANELS
 PROJECT: WPS / PULLIAM POWER PLANT PULLIAM 8 / ALLIS CHALMERS 125 MW STEAM TURBINE GENERATOR

TITLE: WOODWARD 505 LST / REXA TURBINE CONTROL PANEL BACK SIDE SUBPANELS
 DATE: 10/19/09
 EDIT: TT
 ENG: TT
 APVD: ENGINEERING GROUP

BACK SIDE SUBPANEL SCREEN PRINT

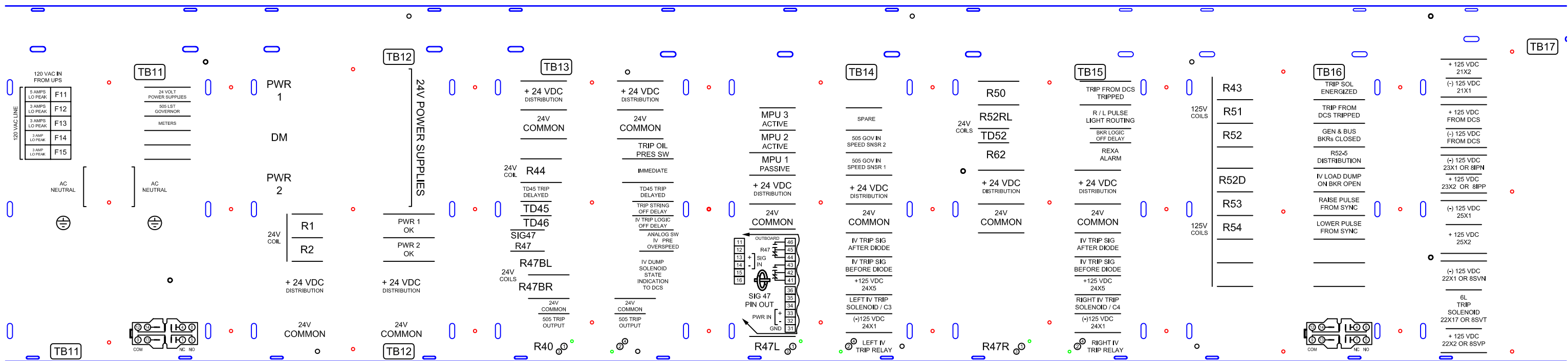

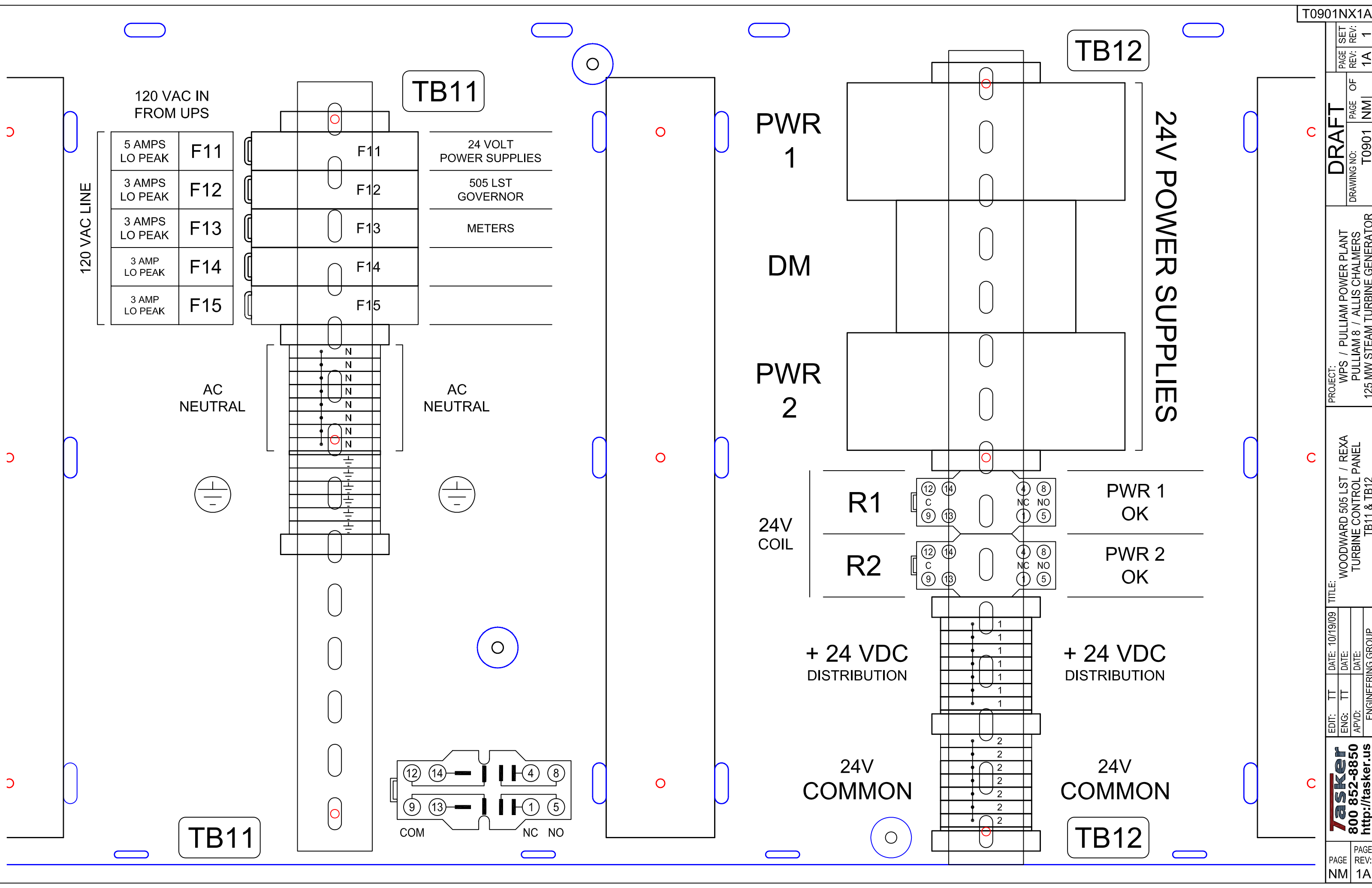

120 VAC IN FROM UPS

5 AMPS LO PEAK	F11
3 AMPS LO PEAK	F12
3 AMPS LO PEAK	F13
3 AMP LO PEAK	F14
3 AMP LO PEAK	F15

120 VAC LINE

AC NEUTRAL



TB11

24 VOLT POWER SUPPLIES

505 LST GOVERNOR

METERS

AC NEUTRAL



TB11

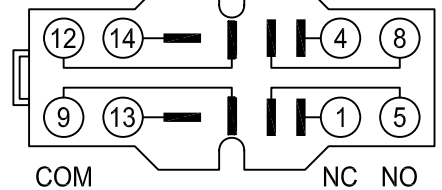

PWR 1

DM

PWR 2

24V COIL

R1

R2

+ 24 VDC DISTRIBUTION

24V COMMON

TB12

24V POWER SUPPLIES

PWR 1 OK

PWR 2 OK

+ 24 VDC DISTRIBUTION

24V COMMON

TB12

TB13

+ 24 VDC DISTRIBUTION

24V COMMON

24V COIL

R44

TD45 TRIP DELAYED

TD45

TD46

SIG47 R47

24V COILS

R47BL

R47BR

24V COMMON

505 TRIP OUTPUT

R40

①

③

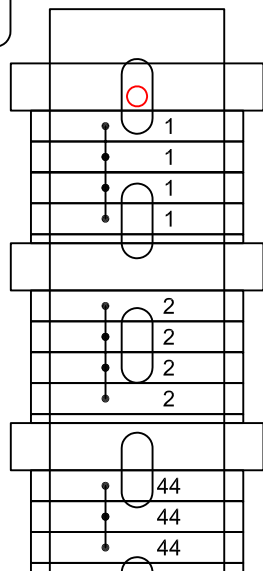

+ 24 VDC DISTRIBUTION

24V COMMON

TRIP OIL PRES SW

IMMEDIATE

TD45 TRIP DELAYED

TRIP STRING OFF DELAY

IV TRIP LOGIC OFF DELAY

ANALOG SW IV PRE OVERSPEED

IV DUMP SOLENOID STATE INDICATION TO DCS

24V COMMON

505 TRIP OUTPUT

R40

②

④

TB14

MPU 3 ACTIVE

MPU 2 ACTIVE

MPU 1 PASSIVE

+ 24 VDC DISTRIBUTION

24V COMMON

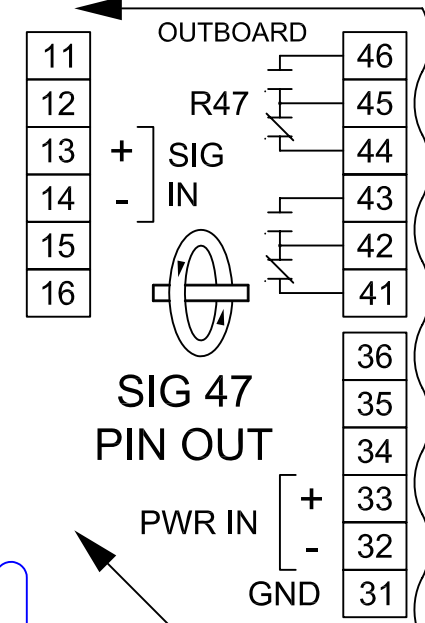

R47L

①

③

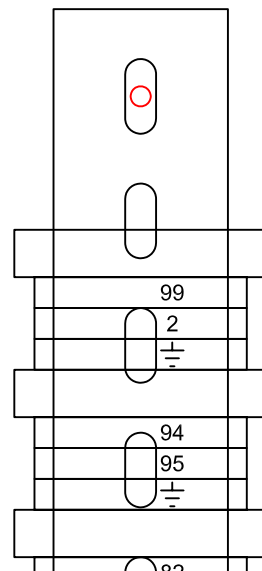

SPARE

505 GOV IN SPEED SNSR 2

505 GOV IN SPEED SNSR 1

+ 24 VDC DISTRIBUTION

24V COMMON

IV TRIP SIG AFTER DIODE

IV TRIP SIG BEFORE DIODE

+125 VDC 24X5

LEFT IV TRIP SOLENOID / C3

(-)125 VDC 24X1

LEFT IV TRIP RELAY

②

④

TB14

MPU 3 ACTIVE

MPU 2 ACTIVE

MPU 1 PASSIVE

+ 24 VDC DISTRIBUTION

24V COMMON

SPARE

505 GOV IN SPEED SNSR 2

505 GOV IN SPEED SNSR 1

+ 24 VDC DISTRIBUTION

24V COMMON

IV TRIP SIG AFTER DIODE

IV TRIP SIG BEFORE DIODE

+125 VDC 24X5

LEFT IV TRIP SOLENOID / C3

(-)125 VDC 24X1

LEFT IV TRIP RELAY

TB15

R50

R52RL

TD52

R62

+ 24 VDC DISTRIBUTION

24V COMMON

TRIP FROM DCS TRIPPED

R / L PULSE LIGHT ROUTING

BKR LOGIC OFF DELAY

REXA ALARM

+ 24 VDC DISTRIBUTION

24V COMMON

IV TRIP SIG AFTER DIODE

IV TRIP SIG BEFORE DIODE

+125 VDC 24X5

RIGHT IV TRIP SOLENOID / C4

(-)125 VDC 24X1

R47R

R47R

RIGHT IV TRIP RELAY

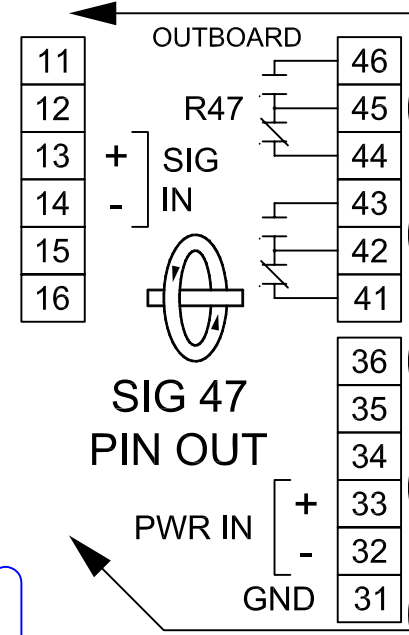

R47L

R47L

24V COILS

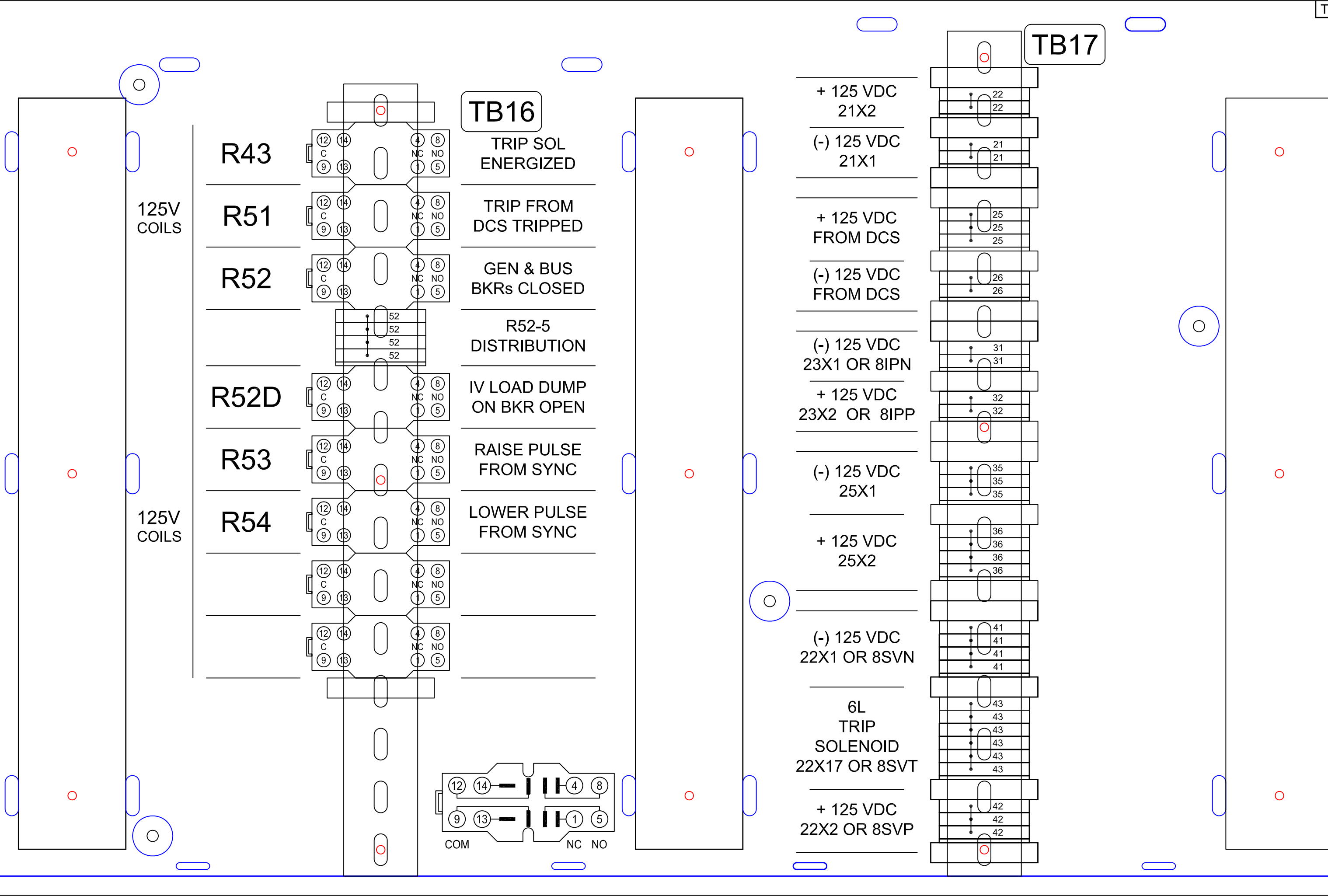

TB16
TRIP SOL
ENERGIZED

TRIP FROM
DCS TRIPPED

GEN & BUS
BKR'S CLOSED

R52-5
DISTRIBUTION

IV LOAD DUMP
ON BKR OPEN

RAISE PULSE
FROM SYNC

LOWER PULSE
FROM SYNC

+ 125 VDC
21X2

(-) 125 VDC
21X1

+ 125 VDC
FROM DCS

(-) 125 VDC
FROM DCS

(-) 125 VDC
23X1 OR 8IPN

+ 125 VDC
23X2 OR 8IPP

(-) 125 VDC
25X1

+ 125 VDC
25X2

(-) 125 VDC
22X1 OR 8SVN

6L
TRIP
SOLENOID
22X17 OR 8SVT

+ 125 VDC
22X2 OR 8SVP

TB17

125V
COILS

125V
COILS

